

Mission-critical support for the mining and aggregate industries



FLS

Delivering premium parts and unparalleled service

As a full-line engineer and provider of replacement parts for extraction and comminution equipment, FLS ensures productivity for mining and aggregate operations worldwide. We add value to your business through more than 80 years of experience in developing and manufacturing parts for end users of mission-critical equipment.

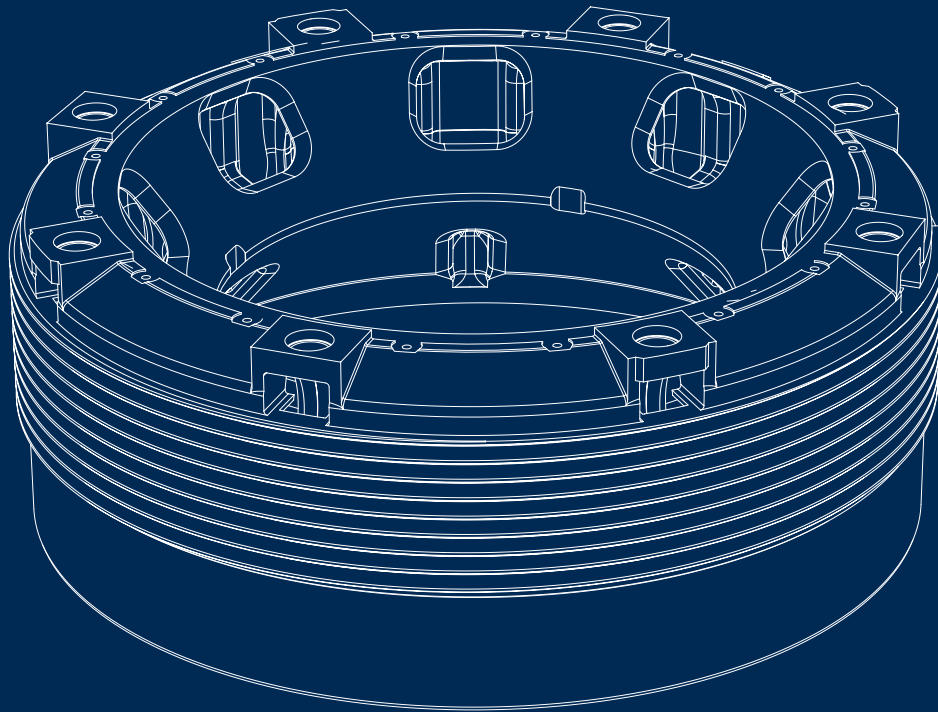

Key benefits

- Reduced downtime
- Lower operating costs
- Improved performance
- Mine-specific design innovations

Superior design, and expertise of critical replacement wear parts

Your machines need to run reliably to keep your business successful. We're here to help keep that equipment operating efficiently.

Our promise to our customers

Without satisfied customers, we cease to exist. This very basic principle is the reason we gear everything we do towards delivering a recognizably higher level of service and quality to you – our customer. This is our passion.

It starts with our employee

In order to consistently deliver great products, superior service and exceptional support, we must establish and maintain a culture that inspires passion for these outcomes. Our employees understand that our goal is to exceed our customers' expectations and prove how much we truly care about their business.



Through extraordinary employees we accomplish extraordinary things.



Crushing and mining replacement wear parts

Providing new levels of customer support

Our team provides support through every step of the purchase process, starting with the initial inquiry, through installation and beyond. From our knowledgeable customer support team to engineers and field technicians that travel the world, we go to great lengths to earn your trust.

Adding value

We provide premium replacement components, designed to add immediate value to your operation. We use the OEM designs as a baseline, not a benchmark. Many components feature performance-driven enhancements formed through more than 80 years of customer collaboration. Downtime is costly – we keep you running.

- Unmatched customer service
- Application-specific design
- Onsite field support



World-class engineering

Once we have first-hand knowledge of your situation, our engineering team goes to work. We bring new ideas to the table and offer application-specific solutions designed for your operation. After you approve the design, the engineering team stays directly involved in the manufacturing process. Once we have assured the fit, form, and function (our F3 commitment) of the new component, our team returns to your site to oversee the installation and initial use.

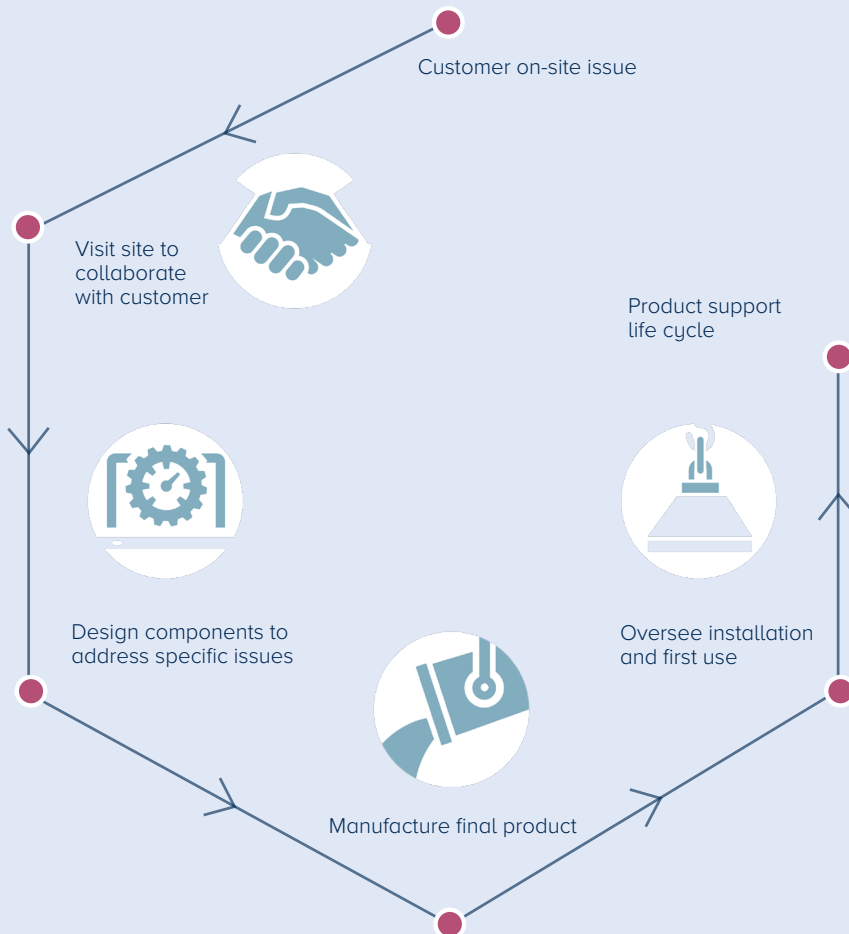
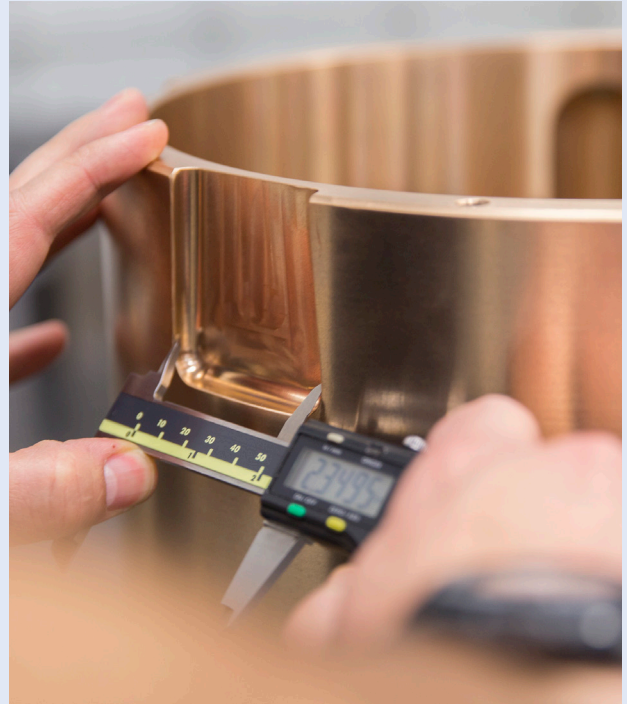

Our F3 commitment

Any accurately identified component part that does not:

1. fit properly into its machine or assembly;
2. provide at least equal “form” properties to that of an original equipment manufacturer-supplied part; or
3. meet original equipment part functionality or wear life, will be repaired or replaced.

Engineering innovation into everything we do

Our engineering and technical experts work directly with customers to find innovative solutions to their unique problems and challenges.

Your performance partners

By partnering with operations around the world, we develop customised solutions for lasting performance in mission-critical equipment. We spend the necessary time to fully understand issues our customers face in the field. You can count on us to be standing by, ready to assist you.

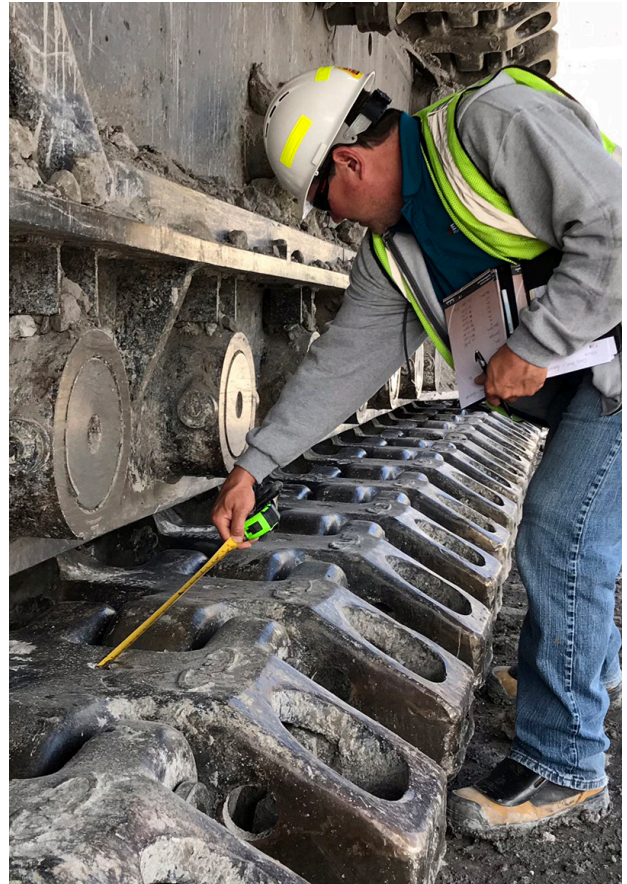

Sentinel™ hydraulic clearing system for Symons® cone crushers

- Greater clearing stroke greatly reduces safety concerns during clearing
- Reduces forces on all major components due to greater tramp release travel
- Allows for maximization of crusher throughput and product gradation
- Bowl adjustment option assists with liner changes and closed side setting

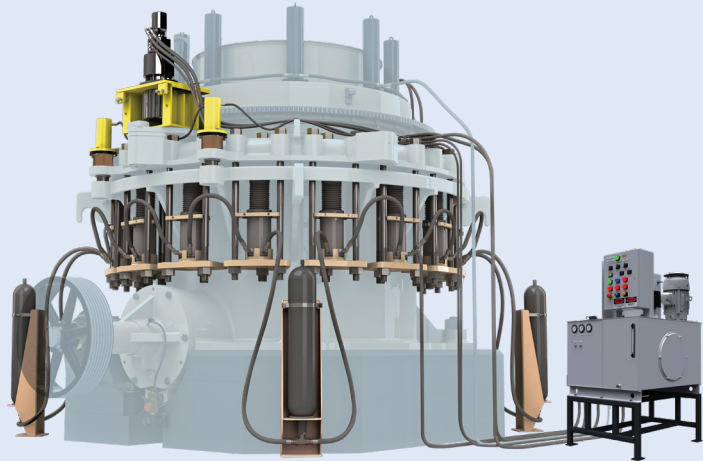

Wide Path™ undercarriage system for electric rope shovels

- Improves overall weight distribution onto track pads
- Produces less direct stress on the track pads
- Reduces wear on track pads, lower rollers, rear idler, drive tumbler, and side frame guide rails
- Significant improvement in lifespan

Wide Path™ is designed to be wider than the conventional system, which increases surface area in the roll path.

The Wide Path components do not require modifications to the existing side frames.



Cone Crusher replacement wear parts

Metso® | Nordberg® | HP®/MP®/GP® | Symons®

Sandvik® | Omnicone® | Allis-Chalmers® | Svedala® | Gyradisc® | Telsmith®



Component assemblies produced for each brand of cone crushers

- Adjustment ring
- Bottom shell
- Bowl
- Countershaft
- Eccentric
- Feed plate
- Head
- Hydraulics
- Liner hardware
- Main frame
- Main shaft
- Pinionshaft box
- Socket
- Spider
- Step plate
- Top shell

ASSEMBLIES

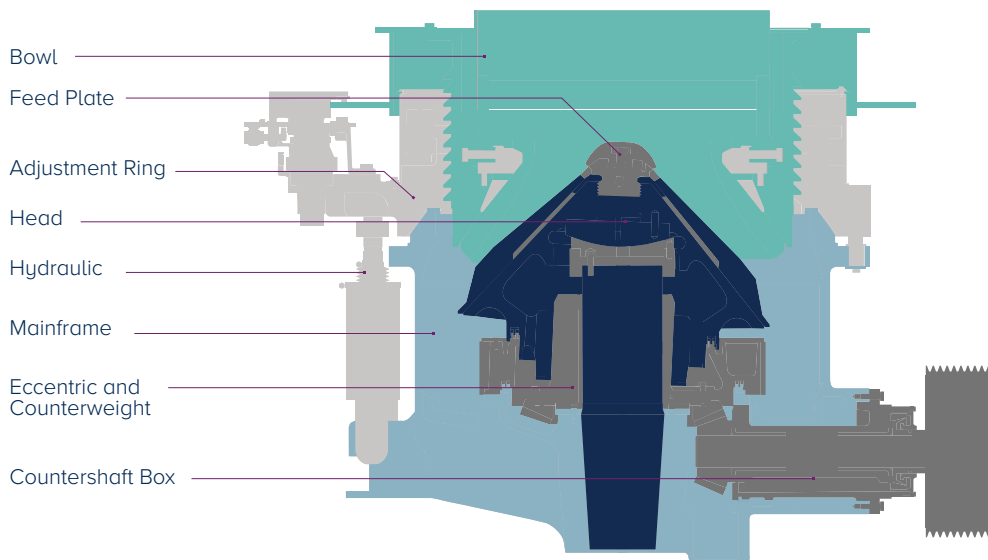

Gyratory Crusher replacement wear parts

Metso® | Nordberg® | Superior®

Sandvik® | Allis-Chalmers® | Svedala® | Thyssenkrupp®



ASSEMBLIES

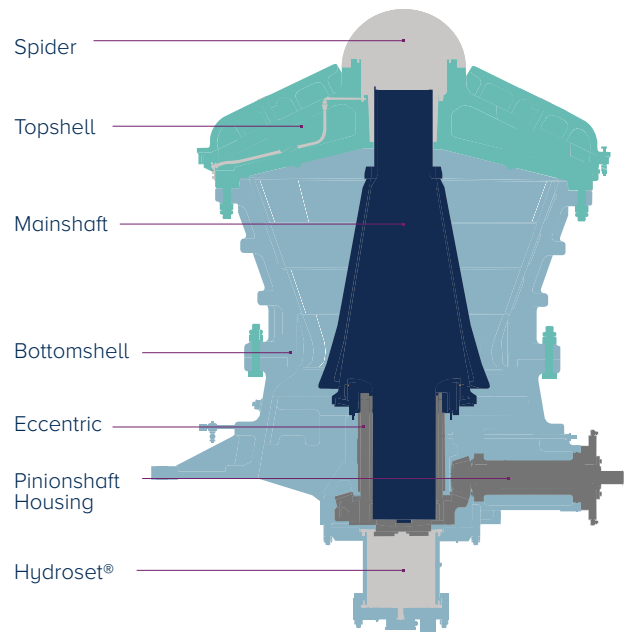

Component assemblies produced for each brand of gyratory crushers

- Bottom shell
- Countershaft
- Eccentric
- Feed plate
- Head
- Hydroset®
- Liner hardware
- Main frame
- Main shaft
- Pinionshaft box
- Socket
- Spider
- Step plate
- Top shell

All brand names, model names or marks are owned by their respective manufacturers. FLSmidth/FLS has no affiliation with the original equipment manufacturer. These terms are used for identification purposes only and are not intended to indicate affiliation with or approval by the OEM. All parts are manufactured by, for and warranted by FLSmidth and are not manufactured by, purchased from or warranted by the original equipment manufacturer.

Hydraulic Excavator replacement wear parts

Hitachi® | Terex® | O&K® | Komatsu® | Demag® | Liebherr®



ASSEMBLIES

Pins & Bushings

Drive Tumbler

Swing Bearing

Upper Rollers

Lower Rollers

Idler

Track Pads

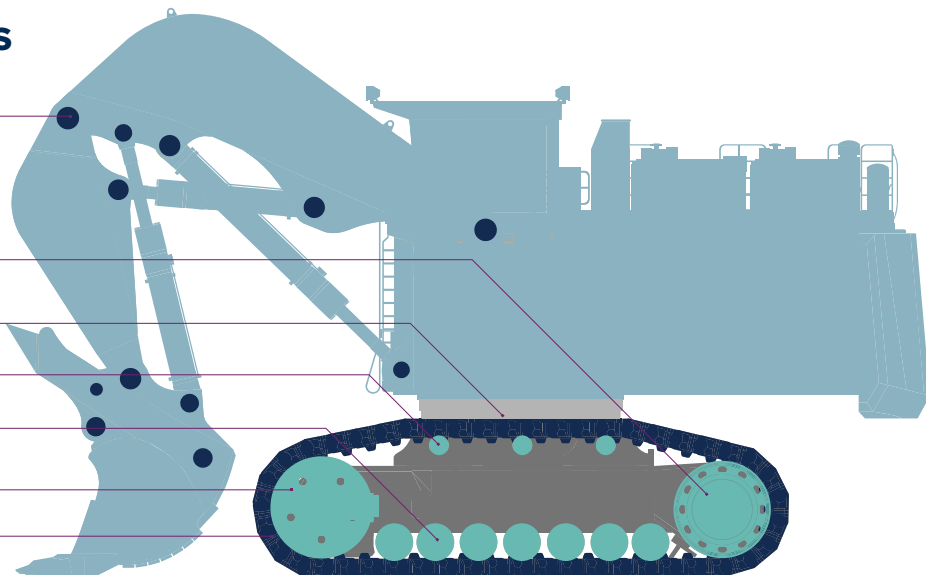

Electric Rope Shovel replacement wear parts

P&H® | Bucyrus®

ASSEMBLIES

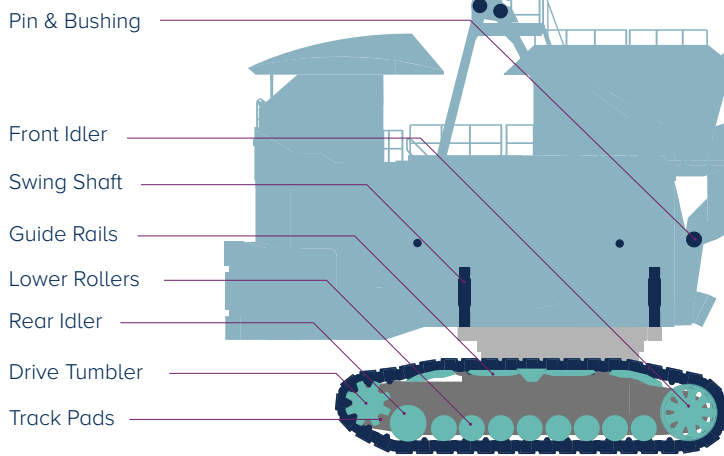

Trunnion Supported Mills replacement wear parts

Marcy® | Allis Chalmers® | Dominion®

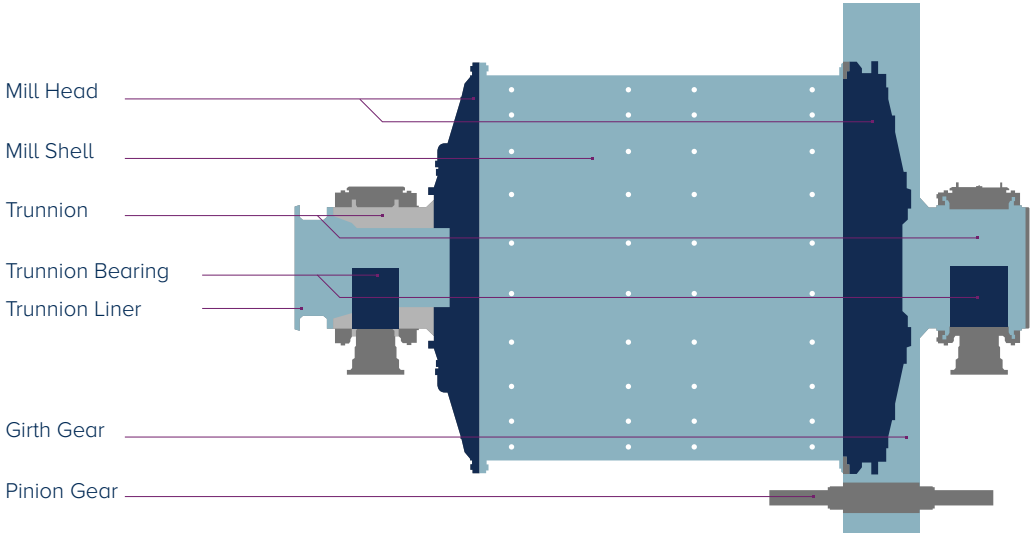

Dragline replacement wear parts

P&H® | Bucyrus® | Marion®

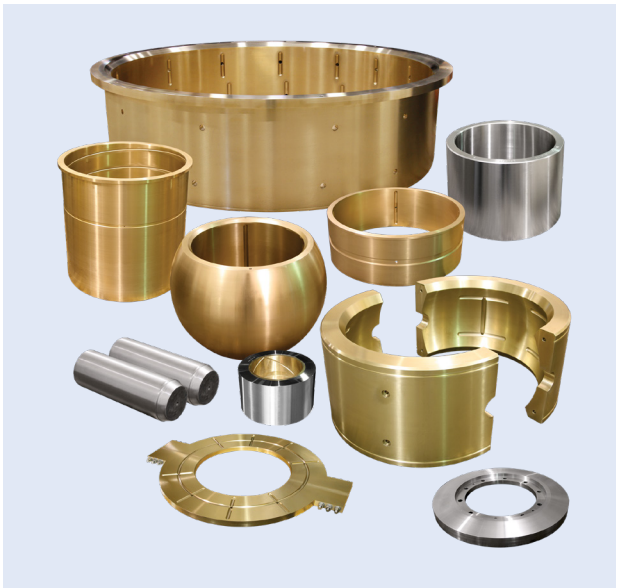
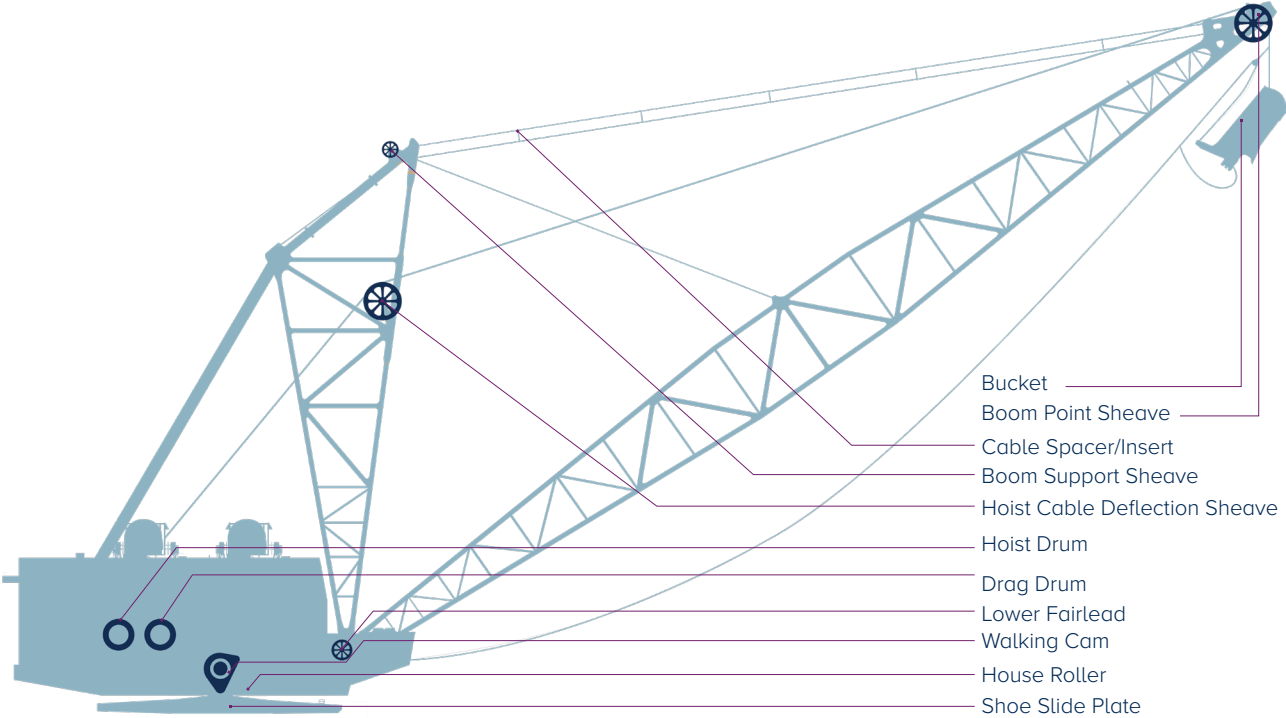

Extraordinary components do not happen by accident

EXCEL™ bronze bushings and components perform better because our standards are higher.

Higher tensile strength

Tin is the most expensive ingredient in the metallurgy of bronze alloys, but it creates tougher bushings that last longer. We use the maximum percentage of tin to increase your profits. We certify our crusher bronze to the top end of the CDA specification for tin.

Uniform lead distribution

During casting, we use an innovative technique that distributes lead and other alloy grains uniformly. We then use a unique chilling process that ensures the uniform distribution is locked in. Our dedication to lead distribution means that when you use EXCEL™ cast alloys, there is less friction and more defense against heat build-up. In short, our bushings and other cast parts last longer and have fewer problems.



Standard bronze pour from furnace to ladle in our foundry for EXCEL parts, located in Pekin, Illinois, USA

Optimum concentricity

Our competitors are content with bushings that are close enough to concentric. We create perfectly concentric bushings using a unique pinch turning method during machining and cut the inside and outside diameters simultaneously. This process guarantees that your bushings are concentric with no weak spots or deformities and lowers the risk of hot spots.

Porosity-free/uniform grain structure

We begin preparing for casting by selecting the highest grade pure raw materials. The unique centrifugal casting technique that we use produces a tighter, denser grain structure in the alloy and eliminates nearly all gas pockets. What does this mean to you? The cast alloys you buy from us last longer and have significantly fewer defects.

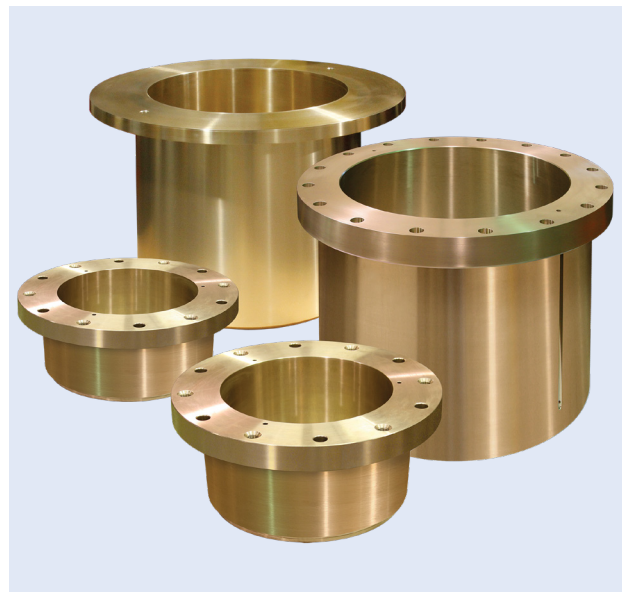

XL40 bronze components



"Our customers need replacement parts that operate in harsh environments. For this reason, we demand metallurgically sound castings produced through the careful control of chemistry and processing parameters for our replacement parts. Our promise is to provide our customers with the highest quality components."

MIKE BERGERHOUSE
Senior Metallurgical Engineer
FLSmidth Inc. - Pekin Operations

Follow us here



flsmidth.com/linkedin



flsmidth.com/twitter



flsmidth.com/facebook



flsmidth.com/instagram



flsmidth.com/youtube

Contact us

FLSmidth A/S

2500 Valby
Denmark
Tel. +45 3618 1000
info@flsmidth.com

FLSmidth Inc.

Pekin Operations
Pekin, IL 61555
Tel +1 309 347 3031
excelparts@flsmidth.com



flsmidth.eco/contact

Copyright © 2023 FLSmidth A/S.
All Rights Reserved. FLSmidth and FLS
are (registered) trademarks of
FLSmidth A/S. This brochure makes no
offers, representations or warranties of
any kind (express or implied), and
information and data contained in this
brochure are for general reference
only and may change at any time.
FLSmidth does not guarantee or make
any representation regarding the use
or the results of the information or the
data provided in the brochure in terms
of its correctness, accuracy, reliability
or otherwise, and shall not be liable for
any loss or damage of any kind
incurred as a result of the use of the
information or data provided in the
brochure.